

**EAST**

**FLAG**

Changzhou East Flag and Display Co., Ltd  
Room 1038, Block 3,  
FengChen international square,  
Changzhou, China

Tel : + 86 519 69817236  
Mob: + 86 13921045712  
[sales@east-flag.com](mailto:sales@east-flag.com)

**EAST**   
**FLAG**

About  
US

EAST  
FLAG

East Flag and Display, your Professional and Reliable Partner.

Focus on the German market for 12 years.

With a wide range products for flags and banners, beachflags, pop up gazebos, SEG frames and lightboxes, counters, tension tube banner stands and fabric walls and so on, we're able to offer you one stop for professional products and reliable services.

We have collected plenty of knowledges for materials, color matching, printing, confection... not only the quality of products plays a very important role in cooperation, but the following series of communications, replies, follow up and order processing will maintain a long-term relationship.

We pride ourselves on listening carefully to our customers and responding by developing innovative products and efficient service that win their trust and today's market opportunities.

"Made in China" has become part of the world, although our product quality has to be improved, our service has been praised by all our customers. We naturally realize this point in our daily contact. When we are sitting together and talking face to face, we become more and more trust each other.

In conclusion, we have three core values that guide our daily activities:

1. Do the right thing, try our best.
2. Being easy to work with, flexible and reliable.
3. Always go for better, better quality, better services for better and happy life!

We're looking forward to establish a long-term cooperation with YOU!

Sincerely,  
East Flag Team



# Product Categories

■ Flags and Banners	1 - 12
■ Beachflags	13 - 22
■ Pop Up Gazebos	23 - 30
■ SEG Fabric series	31 - 38
■ Tension Fabric Displays	39 - 44
■ Pop Up Wall	45
■ A frame	46
■ Table Cover	47
■ Caps	48

# Advertising Flag

Advertising flags are versatile and can be used anywhere. They are an absolute eye-catcher in front of corporate buildings, at public squares or streets.



## Confection



## Color chart



Pantone C

HKS K



RAL

CMYK



## Product Details

Print techniques screen print  
direct digital print

Material knitted polyester 110 g/m<sup>2</sup>  
woven polyester 160 g/m<sup>2</sup>  
mesh polyester 125 g/m<sup>2</sup>



## Vertical flags

Confection hoist high with hooks  
extra with hemstitch on top

Typical size 100 x 300 cm  
120 x 300 cm  
120 x 400 cm  
150 x 400 cm  
150 x 600 cm

## Horizontal flags

Confection hoist cross with ropes  
hoist cross with hooks

Typical size 100 x 150 cm  
120 x 200 cm  
150 x 250 cm  
200 x 300 cm  
200 x 335 cm



# Indoor Banner

Indoor banners can be nice decorations for anywhere for your indoor rooms, halls and shops. They're one of the best advertising media. You can have any of your imagination to be printed on it.



## Confection

Up and down with diameter 12 mm wooden bar, hemstitch made by self fabric 3 cm flat.

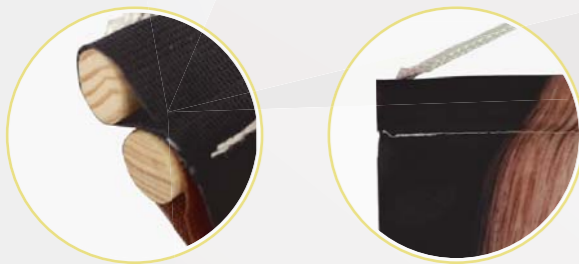

# Outdoor Banner

Outdoor banner is a solid alternative to flags and pennants. This durable communication solution provides extra visibility for your company premises, shop, event or facade.





# Stretch / Mesh Banner

Stretch banners are the ideal supplement to flags. They can be mounted easily in many different places and their eye-catching appearances ensure maximum impact for your advertising slogan.



Mesh banners decorate bridges, fences, buildings, and are used for sporting events, trade shows or promotions.

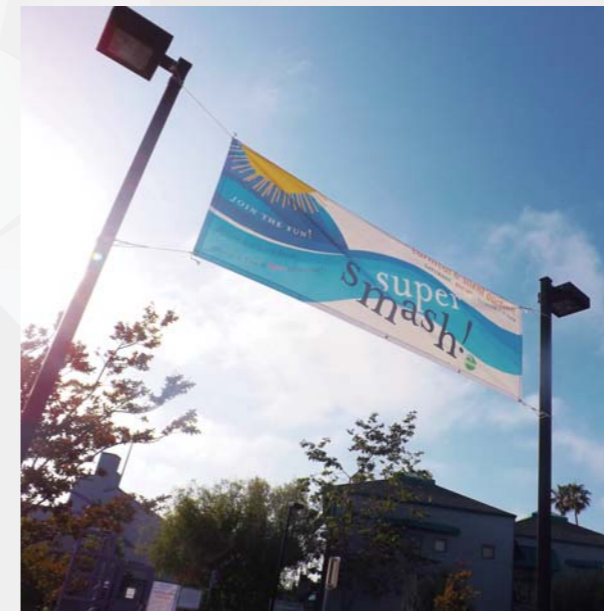

## Product Details

Print techniques	screen print direct digital print
Material	knitted polyester 110g/m <sup>2</sup> mesh polyester 125g/m <sup>2</sup>
Color	Pantone C HKS K RAL CMYK
Typical size	80 x 200 cm 100 x 200 cm 100 x 300 cm 100 x 400 cm

Rope 3m long



Eyelet



D-ring

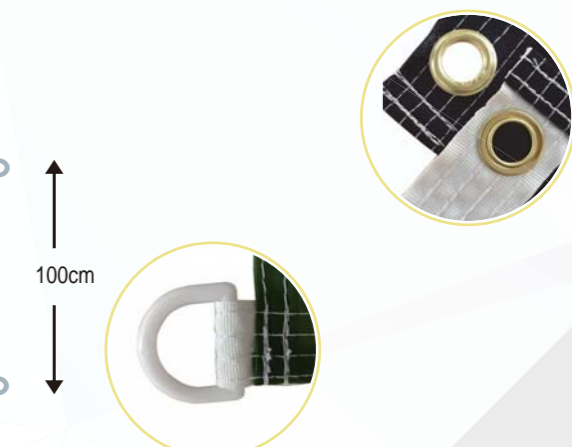



# National / State Flags

National flags and state flags used in various areas, such as next to corporate and advertising flags or next to city and community flags, etc.



## National flags

National flags represent your country, your community, they can be used in different kind of event, occasion and festivals.



## Confection

National flags will be made from different kind of confections based on the flag size, flag type, and the place they are hanging.

# Hand Flags

Hand flags are suitable for parades, supporting groups, merchandising and sporting events, etc.

When you cheer for a football match or other exciting activities, hand flag will activate the atmosphere and also can be used as a souvenir.



## Confection

1. Left side wooden stick or PVC tube
2. All the other three sides with double stitched/single stitched/hot cut



PVC tube 12 mm diameter / Wooden stick 12 mm diameter





# Car Flags

Car flags are perfect as a means for supporter groups to display their logos and colors. They can be easily attached to vehicles and be able to removed and reattached wherever you want them.

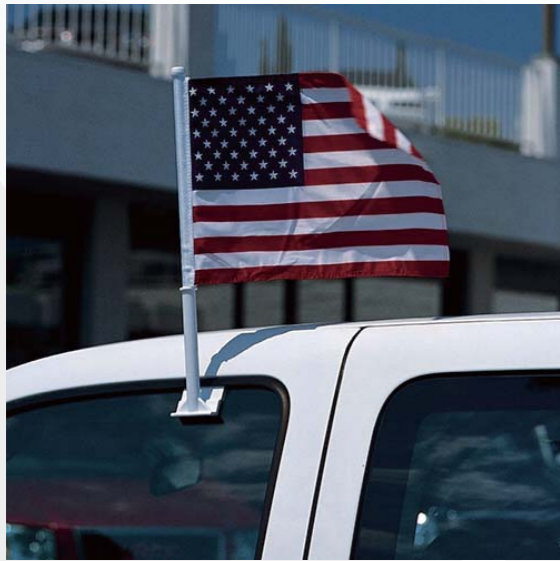

Large carflag pole

Flag size 30 x 45 cm



Small carflag pole

Flag size 30 x 45 cm



# Bunting flag

Bunting flag is a term for any festive decorations in imitation of fabric. It's used at city festivals, in product presentations or company celebrations. Pennant chains give events an exclusive, individual framework.



## Confection

1. Sewing together the flags with rope or webbing
2. Flags can be hot cut, single stitched or double stitched

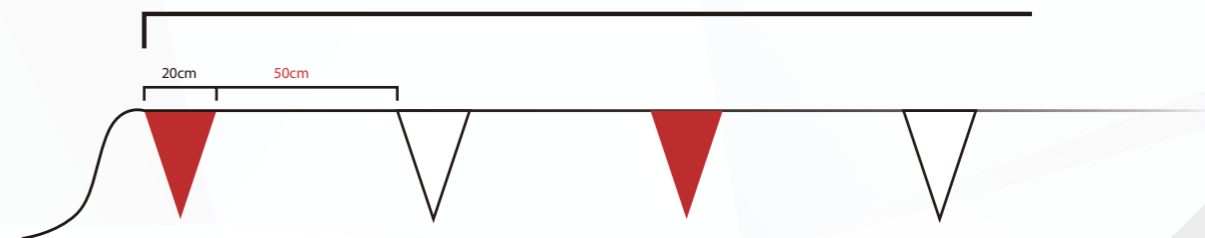

# Table Banners

We offer table banners and table pennants with cord border and suspension or with fringes, printed on one or both sides and custom-made items.

Most common size 15 x 25 cm and 20 x 30 cm, other custom sizes will be offered on request.



## Banner Stand Options

With chrome base and telescopic pole



EF-T01 EF-T02 EF-T03 EF-T04



# Pennants

Custom Printed Sports Banners and Pennants for your sports club, high quality and luxury pennants in various sizes, fully finished off with multi colour trim.



## Products Features

- 1. heat transfer digital print
- 2. double sided with interlining
- 3. with wooden or steel bar on top
- 4. with cord border or fringes
- 5. short delivery time
- 6. any sizes can be customized



# Beach Flag–Classic Shape

Beach flag Classic comes with four different shapes with 4 different sizes, we totally offers 16 solutions for your advertising and event show.

We're able to customize any sizes based on requirements, both for the parts of flag poles and beachflags.

Size	Final Height	Width
S	220cm	50cm
M	280cm	65cm
L	340cm	70cm
XL	390cm	80cm

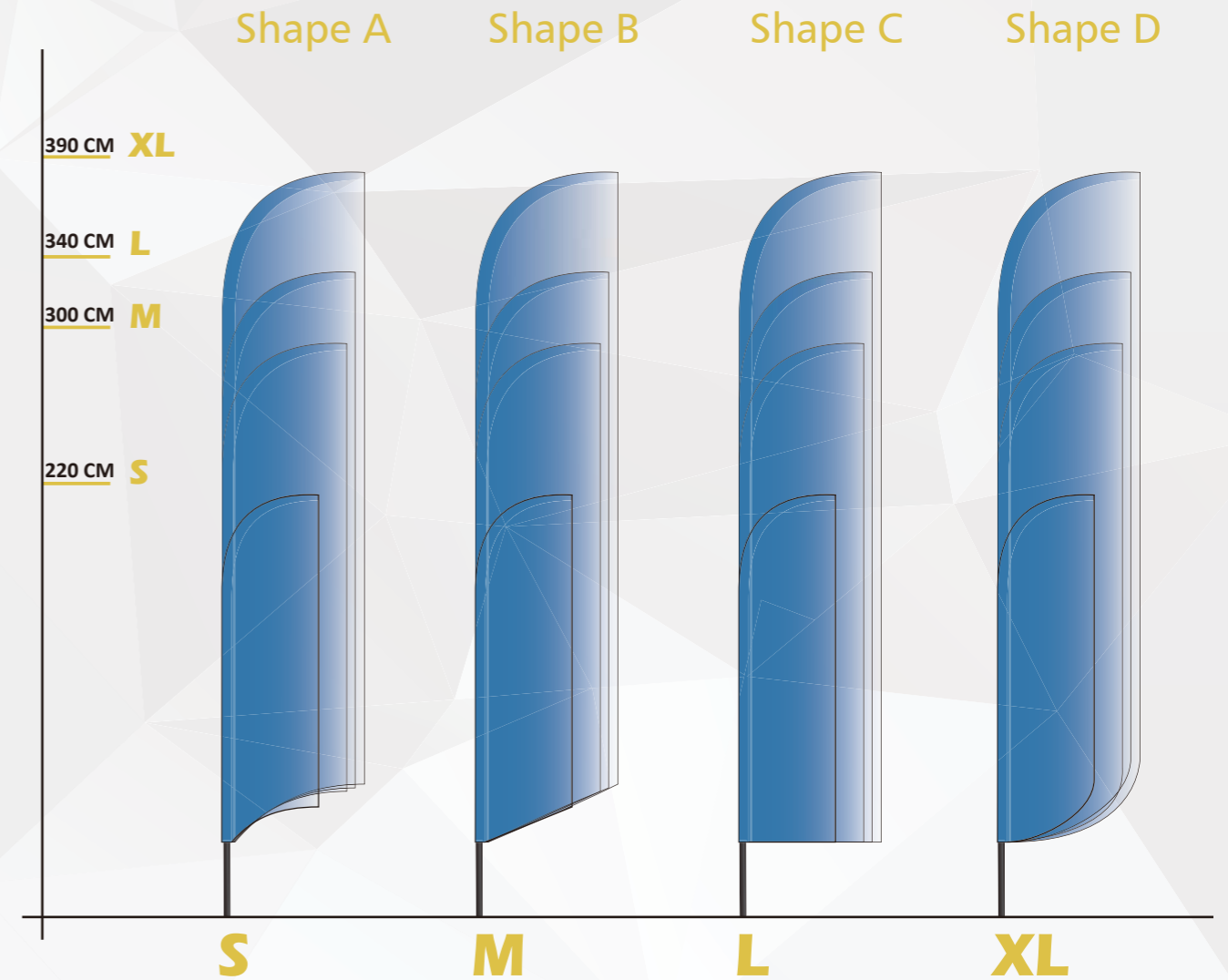

### Black elastic band hemstitch

1. the most stable sleeve for beachflag
2. well kept the flag shape smooth
3. The most convenient for graphic preparation



All the classic beach flags come with one burl fiber glass pole and 2-3 burls aluminum poles, this combination brings the best solution for the flag shape.



# Beach Flag-Drop Shape

Beach flag drop is a highly visible solution for indoor and outdoor applications. It is quick and easy to erect. They are sure to draw attention in any setting, in the mountains and by the sea, even a trade show or at company for product presentations.

Size	Final Height	Width
S	230cm	75cm
M	280cm	85cm
L	320cm	95cm
XL	360cm	105cm

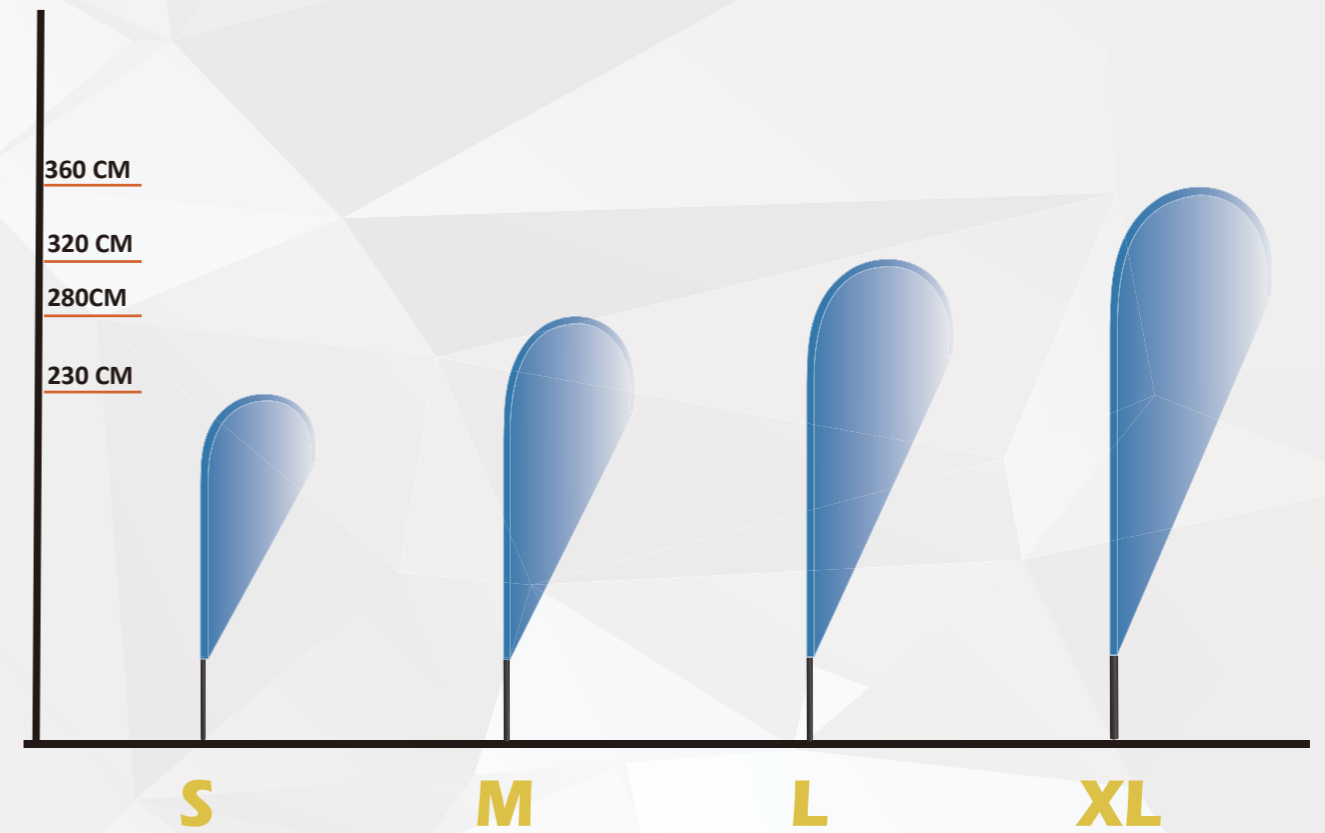

### Black 600D oxford hemstitch

1. Very stable quality sleeve for beachflag
2. Easy for installation
3. The most convenient for graphic preparation



All the drop beach flags come with two burls fiber glass pole and 2-3 burls aluminum poles, this combination brings the best solution for the flag shape.



# Beach Flag – Square shape

Square beach flag is commonly used for festivals, performances, athletic competitions and other popular events. This model is perfect for flags with a rectangle shape. It is a versatile promotion system which, owing to changeable bases, can be presented outdoors as well as indoors.

Size	Final Height	Width
S	230cm	50cm
M	300cm	70cm
L	345cm	85cm



Top Right Corner



Top Left Corner For Bent Pole

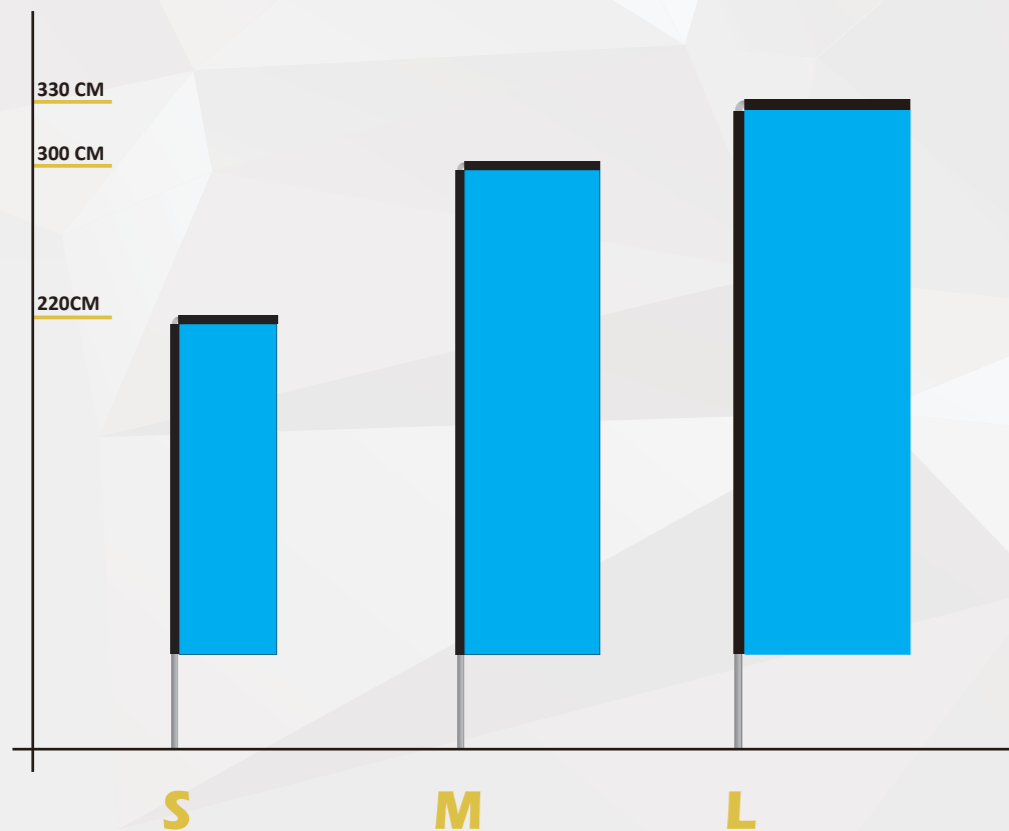

## Fixing System For All Beachflags

1. Very stable quality
2. Flexible for moving when installation
3. No worry for loose
4. Well kept the flag tension and shape
5. Nice outlooking

## Oxford Carry Bag

1. Double layered or single layer at request
2. 100 cm and 118 cm long
3. Pack the poles , flags , and bases at separate pocket
4. can be customized





# Beach Flag-Bases

Metal plate with a black/grey surface coating is stable for indoor or outdoor base solution. It adds surface area to the ground and does not allow the stake to move or be pulled out.



Metal Plate **EF - MP01**

300 x 300 x 5 mm, 4.0 kgs  
Single axis  
Black/Grey coated  
Indoor



Metal Plate **EF - MP02**

400 x 400 x 5 mm, 6 kgs  
Axis with bearing  
Black/Grey coated  
Indoor and outdoor



Metal Plate **EF - MP03**

500 x 500 x 5 mm, 10.0 kgs  
Enhanced axis with bearing  
Black/Grey coated  
Indoor and outdoor

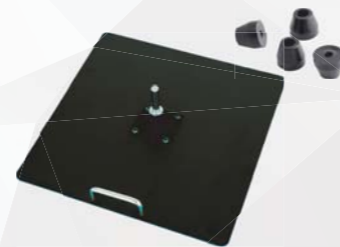

Metal Plate **EF - MP04**

500 x 500 x 8 mm, 15.0 kgs  
Enhanced axis with bearing  
Rubber feet optional  
Outdoor



Rubber Plate **EF - RP01/02**

500 x 500 x 50 mm, 10.0 kgs  
580 x 580 x 80 mm, 15.0 kgs  
Enhanced axis with bearing  
Super anti-Rust  
Outdoor



Wall mounting base **EF - WMB01**

100 x 100 mm, 0.7 kgs  
45,90,180 degree  
Axis with bearing  
Rubber feet optional  
Outdoor

# Beach Flag-Bases

Cross base is ideal for exhibitions and indoor use. It has advantages to be set up with your beach flag quickly and easily. It can also fold flat so that you can transport convenient. A water bag is recommended to equip with together, when it used in outdoors, for the purpose of adding stability.



Clasic Cross Base  
**EF - CB01**

78 x 68 cm, 1.2 kgs  
Black coated  
Indoor and outdoor



Flat Cross Base  
**EF - CB02**

82 x 72 cm, 4.0 kgs  
72 x 62 cm, 2.8 kgs  
Axis with bearing  
Indoor and outdoor



4 leg Cross Base  
**EF - CB03**

76 x 76cm, 2.65 kgs  
96 x 96 cm, 2.95 kgs  
116 x 116 cm, 3.5 kgs  
Axis with bearing  
Indoor and outdoor



Water Bag  
**EF - WB01**

Dia 59 cm, 15 L capacity  
PVC material  
For adding stability

# Beach Flag-Bases

Ground Spike - with double bearing and always turns with the wind, grounds spikes are the most popular accessory for your beach flag.

Ground screw - they are engineered designed to be free rotating, not rip in the wind and allow the flag to sway in the breeze.



Metal Spike  
EF - MS01

60 cm long, 12 mm dia, 1.0 kgs  
Axis with bearing



Metal Spike  
EF - MS02

60 cm long, 15 mm dia, 1.1 kgs  
Axis with bearing



Metal Spike  
EF - MS03

60 cm, 12 mm dia, 1.2 kgs  
Axis with bearing



Metal Ground Screw  
EF - MGS01

50 cm, 1.5 kgs  
Rotatable axis  
Black coated



Metral Ground Screw  
EF - MGS02

60 cm, 0.95 kgs  
Axis with bearing  
Zinc coated



Plastic Ground Screw  
EF - PGS01

60 cm, 0.9 kgs  
Rotatable axis  
ABS material

# Beach Flag-Bases

Water base with a trendy appearance is based for indoor/outdoor use. It is made of hard plastic. Once this base is filled with water, it will allow you to anchor the base to the hard surface.



Round Water Base EF - WB1

Dia 42 cm, 15L capacity  
Rotatable axis  
ABS material



Square Water Base EF - WB2

Dia 48 cm, 22L capacity  
Rotatable axis  
ABS material



Printable Water Base EF - WB3

Dia 40 cm, 15L capacity  
Rotatable axis  
ABS material



Car feet EF - CF01

50 x 38 cm, 2.0 kgs  
Axis with bearing  
outdoor



# Pop up Gazebo-Pro HEX 50 Series

Our Aluminum Pro Hex 50 Series outdoor pop up gazebos are a range of strong, durable and waterproof outdoor shelters. They be used and reused at many events.

They are popular with professional marquee companies, councils, market operators, professional outdoor catering companies and event organizers.



## Spare Parts

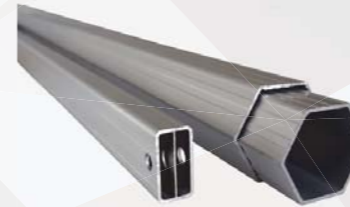

Pole: 50 x 57 x 1.8 mm  
Rib: 35 x 18 x 1.8 mm



Fixed leg truss bar connector



Foot plate



Sliding leg adjuster



Sliding leg truss bar connector

The heavy frame of this pop up gazebo comes fully assembled and is constructed from tough anodized aluminum with aluminum cross bars.

In addition, its frame boasts high-quality cast aluminum sliders and connectors and sturdy 57mm hexagonal alloy legs with large triangular steel footplates with staking holes for secure anchoring.

## Size Specifaction

Size	Carton Size	N.W / G.W	QTY / 40'
3 x 3m	160 x 34 x 36cm	39 / 43 kgs	310 sets
3 x 4.5m	160 x 45 x 36cm	53 / 57 kgs	230 sets
3 x 6m	160 x 59 x 36cm	70 / 75 kgs	180 sets
4 x 4m	210 x 34 x 36cm	51 / 55 kgs	240 sets
4 x 6m	210 x 45 x 36cm	66 / 71 kgs	180 sets
4 x 8m	210 x 59 x 36cm	81 / 87 kgs	135 sets

# Pop up Gazebo –Pro HEX 40 Series



Our Aluminum Extreme 40 Series pop up Gazebos are a great choice for any user looking for a professional, strong and reliable unit.



This range of marquees is a popular choice among the emergency services, event organizers, food and drink vendors and motorsport teams to name a few.



## Spare Parts



Pole: 40 x 45 x 1.5 mm  
Rib: 26 x 13 x 1.3 mm



Fixed leg truss bar connector



Foot plate



Sliding leg adjuster



Sliding leg truss bar connector

The high strength aluminum extrusion framework is both robust and sturdy and with its multi ribbed construction, offers maximum strength and durability, yet remains lightweight for ease of handling and transportation.

## Size Specifaction

Size	Carton Size	N.W / G.W	QTY / 40'
3 x 3m	160 x 28 x 28cm	26 / 29 kgs	450 sets
3 x 4.5m	160 x 37 x 28cm	35 / 38 kgs	340 sets
3 x 6m	160 x 48 x 28cm	46 / 50 kgs	270 sets
4 x 4m	210 x 28 x 28cm	33 / 37 kgs	340 sets
4 x 6m	210 x 37 x 28cm	40 / 43 kgs	260 sets
4 x 8m	210 x 47 x 28cm	50 / 54 kgs	200 sets



# Pop up Gazebo-Pro HEX 29 Series

Our Heavy Duty Steel 29 gazebo range is an ideal entry level shelter, robust enough to handle regular summer and light winter use and offers exceptional value for money without compromising on quality.



Suitable for a variety of leisure uses including garden parties, fetes, fundraisers and even car boot sales! It has also proven a popular choice for charity fundraisers, schools, start-up businesses, professional tradesmen, youth clubs and caterers to name a few.



## Spare Parts

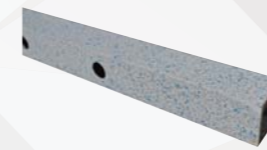

Pole: 29 x 29 x 1.0 mm  
Rib: 22 x 10 x 0.7 mm



Fixed leg truss bar connector



Foot plate



Sliding leg adjuster



Sliding leg truss bar connector

The commercial grade steel framework is both reliable and durable; the frame comes fully assembled and can be set up in under 60 seconds.

## Size Specifaction

Size	Carton Size	N.W / G.W	QTY / 40'
3 x 3m	156 x 22 x 25cm	29 / 31 kgs	650 sets
3 x 4.5m	156 x 22 x 35cm	34 / 37 kgs	470 sets
3 x 6m	156 x 22 x 43cm	49 / 52 kgs	380 sets

## Pop up Gazebo – Cover



Plain, unprinted marquees are available in various colors 450gsm rip stop polyester with PVC coating inside to ensure complete rain proofing.



Our custom printed gazebos can be personalized, giving you a fantastic opportunity to promote your brand, company or products at both indoor and outdoor events, so you can create an attractive and powerful advertising front for your business!

### Canopy & Sidewalls Features

1. Screen printed on colored or plain fabrics for top cover, valances and sidewalls
2. Heat transfer digital print for all parts
3. with PVC/ PU coating inside to ensure complete rain proofing
4. 100% Waterproof and UV stable fabric
5. Canopy stress points are reinforced with additional fabric
6. Multi stitched seams with heat sealed tape to ensure waterproofing
7. Quick fit velcro system to connect sidewall to canopy
8. Fully zipped corners

### Sewing Details



## Pop up Gazebo – Accessories

### Foot Weight And Sand Bag



8/12 kgs

14 kgs

20 kgs

10/20 kgs

30 kgs

### Wheeled Bags

1. Made from heavy duty polyester with durable polyester lining
2. Aluminum base plate with large wheels
3. Fitted with good sized grab handles and two wheels for ease of manoeuvrability



### Beach Flag Holder





## Single Sided SEG Frame

Single sided SEG frame can be used as a free standing banner, hanging display or a wall mounted painting.

Frame sizes can be customized.

Normal sizes for single sided SEG frame are as follows:

80 x 60 cm, 80 x 120 cm, 100 x 120 cm, 120 x 160 cm, 200 x 100 cm, 200 x 150 cm, 200 x 300 cm.

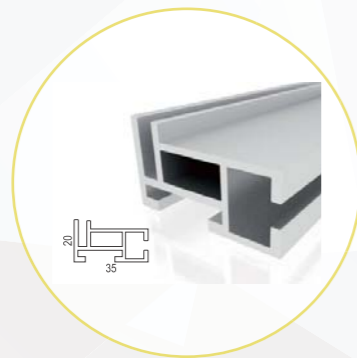

### Product Highlights

- Fast and easy to assembly
- Printed on one side
- Optionally with foot
- Stabilizers are built into the frame
- Motif changes possible at any time
- Crease-free, machine washable prints
- Free standing, wall-mounted options available
- Aluminum clamping frame including pressure

## Double Sided SEG Frame

Double sided SEG frame are ideal for use as advertising boards, room dividers, trade fair or press wall and as ceiling hangers. They are also perfect for shop advertising in almost any format.



Normal sizes for double sided SEG frame are as follows:

100 x 200 cm, 120 x 200 cm, 150 x 200 cm, 200 x 80 cm, 200 x 100 cm, 200 x 120 cm, 200 x 150 cm, 230 x 100 cm, 230 x 150 cm.



## Single Sided SEG Lightbox

Single sided light boxes are the best option for life-like signage. They can be sure to capture shoppers' attention inside the retail setting, day or night. They can showcase the company logos, advertisements in tradeshow or other events, as floor stand or for wall mounting.

Frame sizes can be customized. Normal sizes for single sided light box are as follows:

100 x 150 cm, 100 x 200 cm, 150 x 200 cm, 200 x 200 cm, 200 x 250cm.

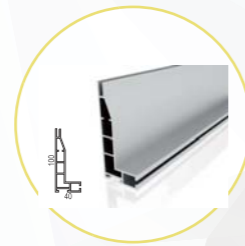

### Features & Service

- All the graphics are printed in heat transfer digital printing
- Maximum print width 320 cm, with high resolution
- High quality B1 elasticized fabrics for perfectly stretched and wrinkle-free polyester 180 g/m<sup>2</sup>.
- Optionally black rubber coating material 250 g/m<sup>2</sup> which block outs the light completely
- Lead time: 3 days at quickest



## Double Sided SEG lightbox

Double sided light boxes with silicone-edged graphics keep images tight and enhance its colors and highlighting what you want to showcase.

Their flat frames are ideally suited for free-standing applications and serve as the ideal customer stopper.

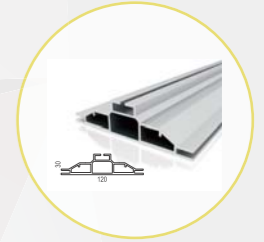
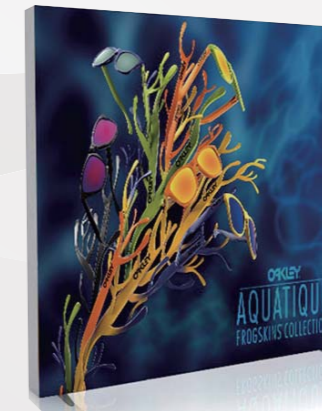



# SEG Counter

SEG counter are the most modern, premium and attractive counter with LED lighting.

With highlighting outlook they catch the attention from far away and capture shoppers' attention inside the retail setting, day or night. They can showcase the company logos, advertisements in tradeshow or other events.



Frame sizes can be customized. Normal sizes for SEG counter are as follows:

80 x 80 x 35 cm, 100 x 100 x 40 cm, 120 x 120 x 45 cm.



## Features & Service

- All the graphics are printed in heat transfer digital printing
- High quality B1 and wrinkle-free polyester 250 g/m<sup>2</sup>
- Faster, easier and tool-free graphic change
- Top and bottom with LED lighting
- Low power consumption through innovative LED technology
- Lead time: 3 days at quickest



# SEG Frame & Fitting System

## SEG frame - Single sided



EF - FS15

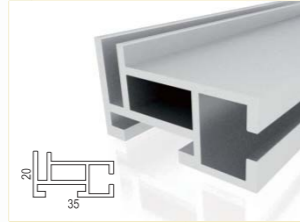

EF - FS20

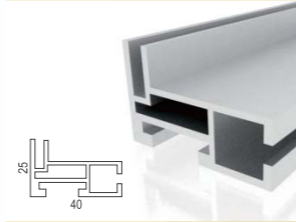

EF - FS25

## SEG frame - Double sided

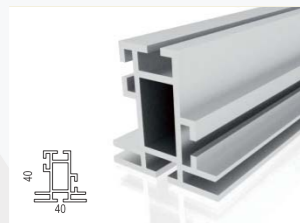

EF - FD40

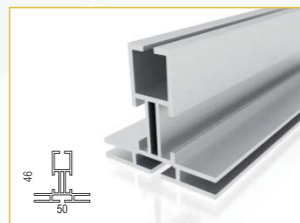

EF - FD50

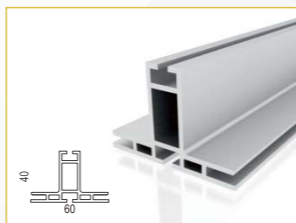

EF - FD60

## SEG lightbox - Single sided

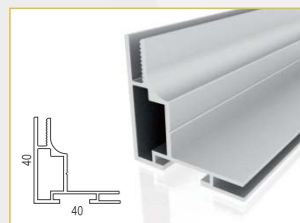

EF - LS40

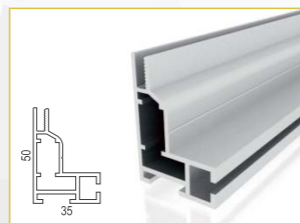

EF - LS50

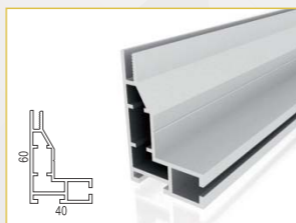

EF - LS60

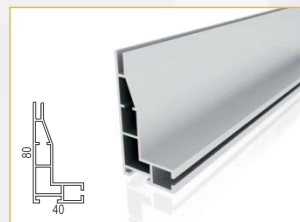

EF - LS80



EF - LS100



EF - LS120

## SEG lightbox - Double sided



EF - LDR100

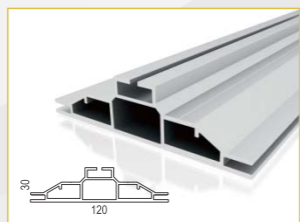

EF - LD120

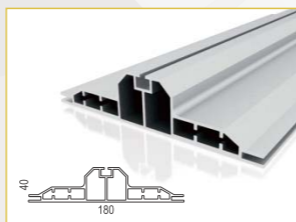

EF - LD180

### Edge-lit Series

Height of light box	Model	Color Temperature	Voltage	LED (PCS)	Power	Length	Ambient Temperature
0.8-2m	M10W24V200	6500K	24V	3	6W	200mm	-40 ~ 60
0.8-2m	M10W24V360	6500K	24V	5	10W	360mm	-40 ~ 60

### Edge-lit Series

Height of light box	Model	Color Temperature	Voltage	LED (PCS)	Power	Length	Ambient Temperature
0.8-5m	M12W24V440	6500K	24V	6	12W	440mm	-40 ~ 60
0.8-5m	M8W24V200	6500K	24V	4	8W	200mm	-40 ~ 60
0.8-5m	M20W24V500	6500K	24V	10	20W	500mm	-40 ~ 60

### Back-lit Series

Depth of light box	Model	Color Temperature	Voltage	LED (PCS)	Power	Length	Mounting angle
40-120mm	09-420	6500K	24V	5	3.5W	420mm	160°
40-120mm	09-510	6500K	24V	6	3.5W	510mm	160°
40-120mm	09-600	6500K	24V	7	3.5W	600mm	160°

Depth of light box	Model	Color Temperature	Voltage	LED (PCS)	Power	Length	Mounting angle
40-120mm	08-300	6500K	24V	4	3.5W	300mm	160°
40-120mm	08-400	6500K	24V	5	3.5W	400mm	160°
40-120mm	08-550	6500K	24V	7	3.5W	550mm	160°



Input: AC-100V~250V  
 Output: DC-12V/24V 100W  
 DC-12V/24V 150W  
 DC-12V/24V 200W  
 DC-12V/24V 250W  
 DC-12V/24V 350W  
 DC-12V/24V 500W



Input: AC-100V~250V  
 Output: DC-12V/24V 60W  
 DC-12V/24V 120W



Input: AC-100V~250V  
 Output: DC-12V/24V 60W  
 DC-12V/24V 100W  
 DC-12V/24V 150W  
 DC-12V/24V 200W





# Easy Banner Stand

Easy banner stand is a tubular frame system, where frame sections fit together to make the shape of the display. It is a pillow case banner that fits snug over the frame to create a seamless and eye catching display.

Alternatively we offer two different bases, steel plate and steel feet.

We're able to customize any sizes on your requests.



Item Nr.	Size	Graphic size (mm)	Weight (kg)	Packing size (cm)
ED 2D1	24"	650 x 2330	2.65	11.5x11.5x79
ED 2D2	36"	960 x 2330	3.97	11.5x11.5x90
ED 2D3	48"	1270 x 2330	5.29	16.5x11.5x84



# Snake Banner Stand

The snake banner stand with aluminum tube frame offers a unique shape to help you stand out from the crowd. It uses dye sublimation printing and all the fabric are with zipper guarantee seamless graphic.

ED 2C1

ED 2C2

ED 2C3



Item Nr.	Size	Graphic size (mm)	Weight (kg)	Packing size (cm)
ED 2C1	915x2280	915 x 3500	5.5	33.5x16.5x80.5
ED 2C2	915x2280	915 x 3000	4.6	33.5x16.5x80.5
ED 2C3	95x2280	915 x 2350	10.0	17.5x23x77



# Tension Fabric Wall

Fabric wall is a great alternative to standard back wall displays. Quickly assembled in just 5 minutes, slide the tubes together to make the frame and lock in place with a push button snap. Then, simply pull the pillowcase-like graphic over the frame and zip it shut.

We're able to customize any sizes according to you requests.

## Straight shape

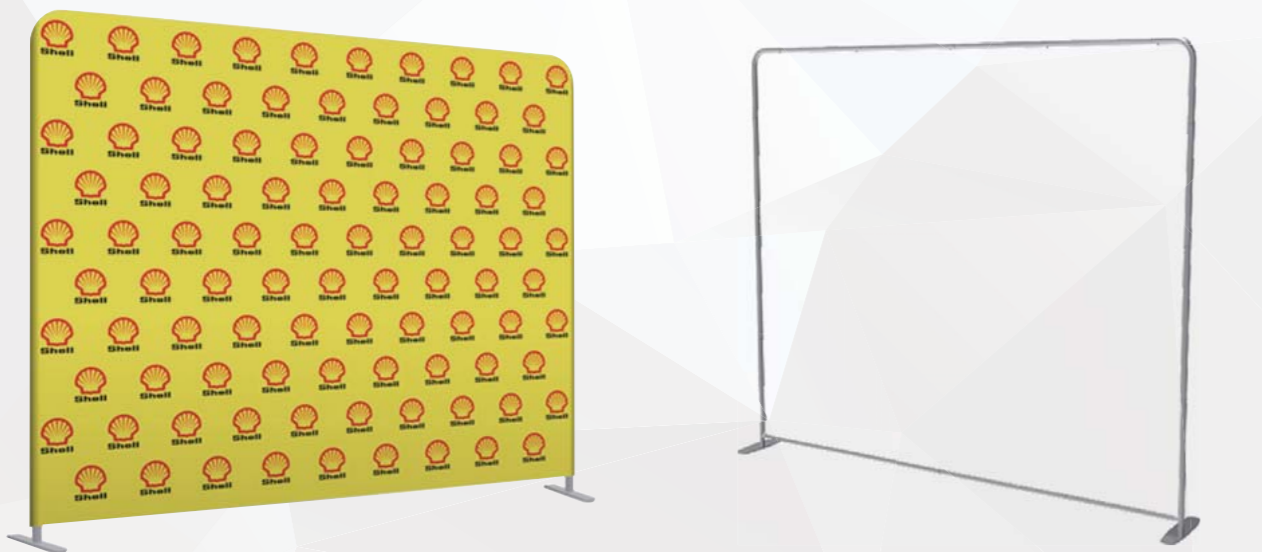

## Size Specification

Size	Graphic size (mm)	Weight (kg)	Packing size (cm)
8ft	2438 x 2280	6.93	27x27x76
10ft	2922 x 2280	7.5	27x27x74
20ft	5960 x 2280	12.85	37.5x37.5x76

## Features

- fast, easy to set up and easy to take down
- flexible, simple and elegant design
- available in different sizes
- configure lights, halogen lamps and LED lamps currently recommended
- each set along with single carry case

## S Shape



## Size Specification

Size	Graphic size (mm)	Weight (kg)	Packing size (cm)
8ft	2438 x 2280	5.8	27x27x74.5
10ft	2997 x 2280	6.4	27x27x88
20ft	5960 x 2280	11.5	37x37x80



# Fabric Counter

Fabric counter display will showcase your products or brand in the best possible way.

It has a base and top supported by three or four poles, the tensioned fabric sock is attached using silicone edged material.



ED FC 01

ED FC 02

ED FC 03

ED FC 04



Item Nr.	Shape	Size	Graphic size (cm)	Weight	Packing
ED FC 01	Oval	595x395x1000	148 x 100	7.5	65.5x11x45.5
ED FC 02	Triangle	600x1000	188 x 100	10.0	63x9.5x63
ED FC 03	Square	1780x885	188 x 100	7.0	39x15x78
ED FC 04	Round	2826x1821x1000	188 x 100	15.0	77x12x78

# Booth Solution



Booth solution could be assembled in various ways and is an exceptional way to display your firm's products and service.

Its' structure combines pillowcase style, together with counter or other display items.



## Features

- Fast, easy set-up
- flexible, simple and elegant design
- Available in different sizes, in flat and curved shape
- configure lights, halogen lamps and LED -lamps currently recommended.
- Each set along with single carry case

# Pop Up Wall

Pop up walls are quick and simple to be installed at media events, exhibitions, conferences and promotions.

Pop up stands are available in many sizes and come with high quality, lightweight, washable fabric prints.



Size	Graphic size (mm)	Weight (kg)	Packing size (cm)
8ft	2250 x 2250	11.0	30x30x83
10ft	3000 x 2250	12.5	35x30x83
20ft	5940 x 2250	24	68x30x83

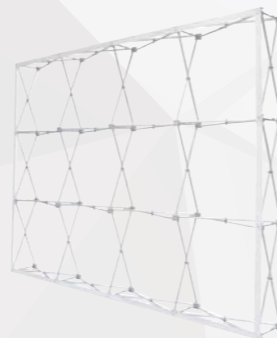

# A Frame

A frame is a great flexible display products that will make your message stand out from the crowd at any event either indoors or outdoors.



### Features

- High visual impact display stand
- Indoor/outdoor use
- Elastic steel with Zinc coated
- Supplied with carry bag and ground pegs
- Extremely portable and lightweight
- Available in different sizes





# Table cover / Table Cloth

Table cover/ Table throw is a great way to draw attention to your trade show or conference table, it helps accentuate visibility to your table and draws notice to your brand's logo or marketing message.

Besides the standard sizes of 6 ft and 8 ft, we're able to customize any sizes on your requests.

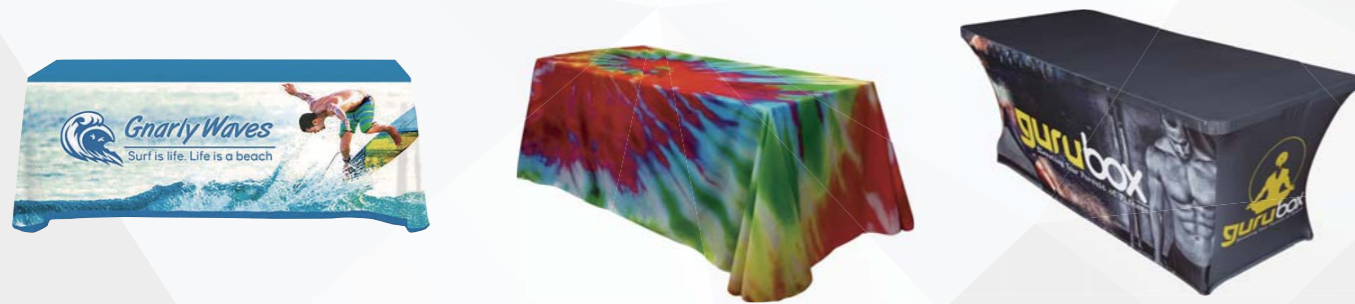

6ft Table Cloth, Open Back

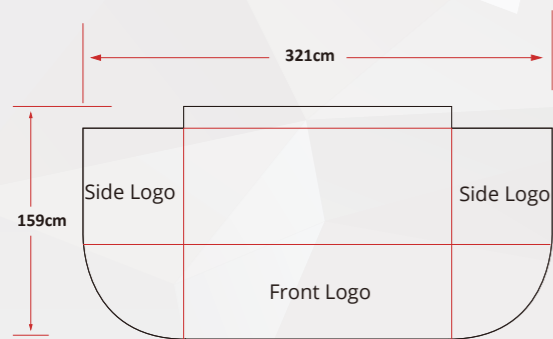

6ft Table Cloth, Full

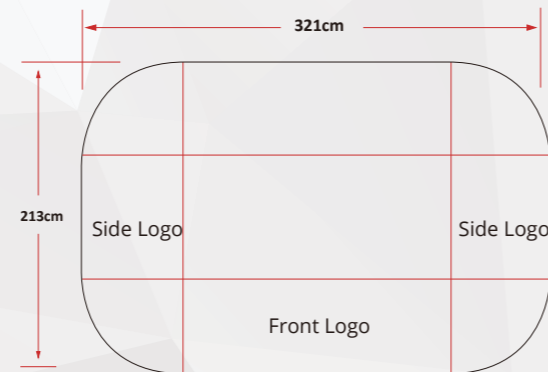

8ft Table Cloth, Open Back

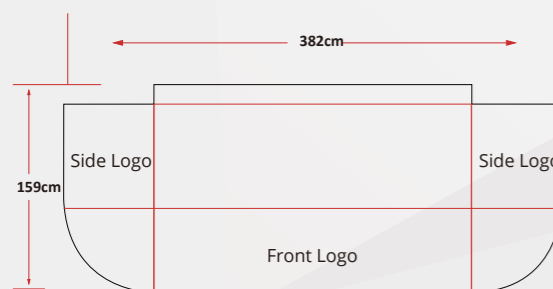

8ft Table Cloth, Full

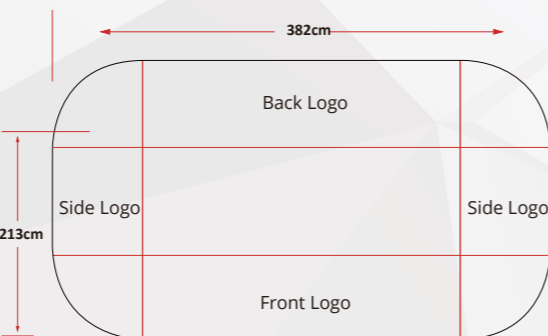

# Caps

Caps are much more an advertising item to catch the attention. With our cooperated professional factories, we're able to offer you any kinds of caps from the markets, which always keep the high quality and standard.

